







FLIR Model MR59

Ball Probe Moisture Meter with Bluetooth®



QUICK STEPS





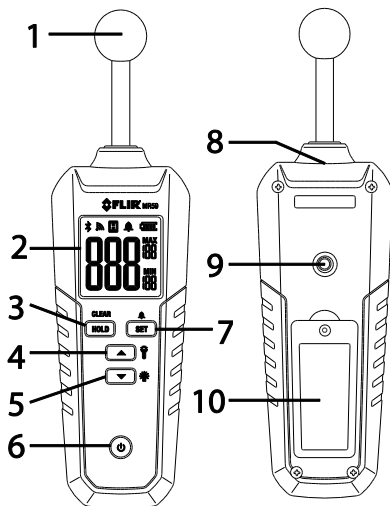

1. Ensure that a 9V battery is installed in the meter's rear compartment.
2. Long press the Power button  to switch the meter ON. The meter will display 'CAL' while it performs a ZERO calibration (keep hands and objects away from sensor during this calibration).
3. The meter automatically switches OFF after 30 minutes (APO).
4. Place the ball sensor on the surface of the material under test. The sensitivity of the sensor is uniform across its entire surface. The sensor can detect moisture to a depth of 100 mm (4") maximum.
5. Read the moisture level in % on the meter display. Take readings in several locations for the best representation of the moisture present.
6. Note the MAX and MIN moisture readings on the display. Long press the **CLEAR** button to reset the MAX/MIN readings.
7. Long press the  button to switch the meter's backlight ON/OFF.
8. Long press the  button to switch the meter's Work Light ON/OFF.
9. To freeze/unfreeze a displayed reading, short press the **HOLD** button.
10. The MR59 beeps when the moisture reading exceeds the high alarm limit. To set the alarm limit, short press the  **SET** button, and then use the up /down arrows to set the value (press  **SET** again to exit). To enable/disable the alarm, long press the  **SET** button. When the alarm is enabled (default), the alarm bell icon appears.
11. Refer to the Bluetooth® section below, and the separate user manual, for information on transmitting readings to a remote device.
12. The micro USB port (battery compartment) allows for System firmware and Bluetooth® firmware upgrades. See the User Manual for details.

METER DESCRIPTION

1. Moisture sensor
2. Backlit LCD
3. Data Hold/MIN-MAX clear
4. Worklight ON/OFF and up arrow button
5. Backlight ON/OFF and down arrow button
6. Power button
7. Alarm SET/Alarm limit button
8. Work light
9. Tripod mount
10. Battery/USB port compartment



FUNCTION BUTTON DESCRIPTION

	Long press to power the meter ON/OFF
CLEAR HOLD	Long press to clear MIN/MAX memories Short press to access/exit Data Hold mode
 SET	Long press to enable/disable the audible Alarm Short press SET to access/exit the alarm threshold screen (use the arrow buttons to change the threshold value)
	In Alarm limit mode, increase the moisture alarm threshold
	In Alarm limit mode, decrease the moisture alarm threshold
	Long press to switch work light ON/OFF
	Long press to the switch display backlight ON/OFF

DISPLAY DESCRIPTION

1. Bluetooth® (BLE) icon (when connected)
2. Transmit icon (when connected)
3. Data Hold icon
4. Alarm enabled icon
5. Battery status icon
6. Maximum reading
7. Minimum reading
8. Moisture reading

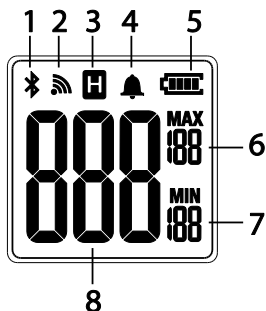



BLUETOOTH® COMMUNICATION

To connect to a remote device running **FLIR Tools™**, turn on the remote device and start the **FLIR Tools™** application. Open **Instruments**, and search for the MR59 (the MR59 must be ON). Tap to connect to the MR59.

When connected to a device running the **FLIR Tools™** mobile app, the MR59 (using the **METERLiNK®** protocol) continually sends readings for live display on the remote device. When connected to a compatible FLIR camera that supports **BLE** (Bluetooth® Low Energy), the MR59 continually sends meter readings for live display on the camera screen.

Download the **FLIR Tools™** mobile app from the Google Play™ store, the Apple App store, or here: <https://www.flir.com/products/flir-tools-app/>

1. When successful communication between the meter and a remote device or FLIR camera is established, the Bluetooth® icon  and the transmission icon  appear on the meter display.
2. Refer to the **FLIR Tools™** help utility in the mobile app for detailed information regarding **FLIR Tools™**.



Publication Identification No.: MR59-QS
Release version: AB
Release Date: August 2018
Language: en-US

Copyright © 2018 FLIR Systems, Inc.

All rights reserved including the right of reproduction in whole or in part in any form.